

AccuForce 12V - 17Ah | VRLA Battery



Specifications

Nominal Voltage	12 V	
Number of cells	6	
Design Life	5 years	
Dimensions	Length	181 mm
	Width	77 mm
	Height	167 mm
	Total Height	167 mm
Approx. Weight	5.3 kg	
Nominal Capacity (25°C)	20 hours rate (0.85 A, 10.5 V)	17.00 Ah
	10 hours rate (1.68 A, 10.5 V)	16.80 Ah
	5 hours rate (3.09 A, 10.5 V)	15.45 Ah
	1 hour rate (11.8 A, 9.6 V)	11.80 Ah
Max. Discharge Current (25°C)	255 A (5s)	
Internal Resistance	16.5 mOhms	
Fully Charged battery (25°C)		
Self-Discharge	3% of capacity declined per month at 20°C (average)	
Operating Temperature Range	Discharge	-20~60°C
	Charge	-10~60°C
	Storage	-20~60°C
Short Circuit Current	850 A	
Charge Methods:	Cycle use	2.30-2.35 Vpc
	Maximum charging current	6.8 A
	Temperature compensation	-30 mV/°C
	Standby use	2.23-2.27 Vpc
Constant Voltage Charge (25°C)	Temperature compensation -20 mV/°C	

Applications

- Uninterruptible Power Supplies (UPS)
- Electric Power Systems (EPS)
- Emergency backup power supplies
- Electronic apparatus and equipment
- Communication power supplies
- DC power supplies
- Auto control system



Battery Construction

Component	Positive Plate	Negative Plate	Container	Cover	Safety Valve	Terminal	Separator	Electrolyte
Raw material	Lead dioxide	Lead	ABS	ABS	Rubber	Copper	Fiberglass	Sulfuric acid

Dimensions

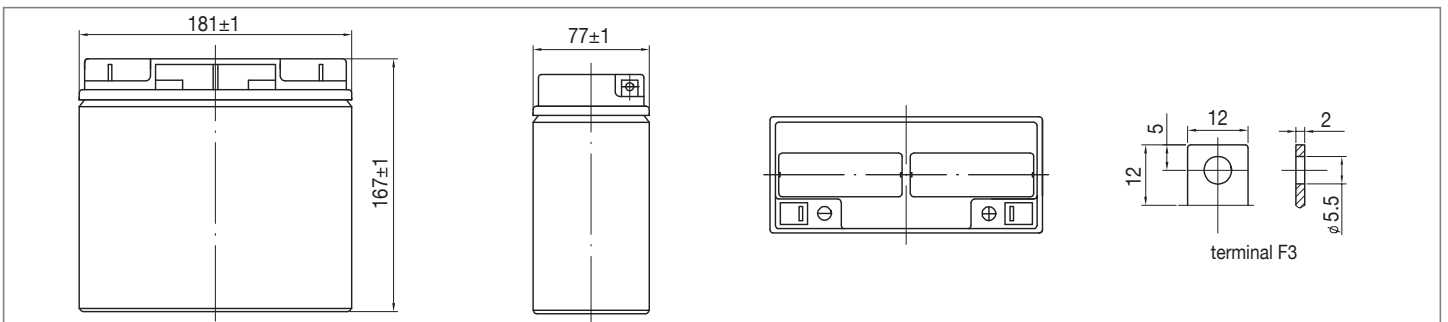

Constant Current Discharge (Amperes) at 25°C

End Voltage (Volts/Cell)	5 min	10 min	15 min	30 min	1 h	3 h	5 h	10 h	20 h
1.60 V	64.9	44.1	34.0	19.8	11.8	4.57	3.09	1.78	0.89
1.65 V	62.8	43.0	33.3	19.4	11.6	4.50	3.03	1.75	0.88
1.70 V	60.5	41.9	32.6	18.9	11.4	4.42	2.97	1.72	0.87
1.75 V	58.0	40.7	31.8	18.4	11.2	4.35	2.91	1.68	0.85
1.80 V	55.3	39.4	30.9	17.9	10.9	4.27	2.84	1.65	0.84

Constant Power Discharge (Watts/Cell) at 25°C

End Voltage (Volts/Cell)	5 min	10 min	15 min	30 min	45 min	1 h	2 h	3 h	5 h
1.60 V	111	78.6	61.3	35.3	27.4	22.4	13.0	9.09	6.13
1.65 V	107	77.2	60.2	34.8	27.1	22.2	12.9	9.01	6.07
1.70 V	103	75.8	59.0	34.3	26.8	22.0	12.8	8.92	6.01
1.75 V	98	74.3	57.8	33.7	26.4	21.7	12.7	8.83	5.95
1.80 V	94	72.8	56.5	33.1	26.0	21.5	12.5	8.74	5.88

(Note) The above characteristics data are average values obtained within three charge/discharge cycles not the minimum values.

AccuForce 12V - 17Ah | VRLA Battery

Temperature Effects on Float Life

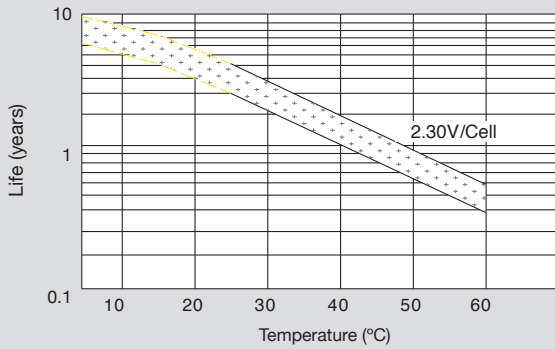

Self Discharge Characteristics

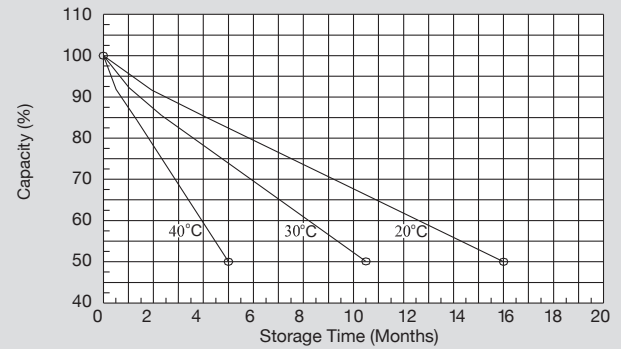

Discharge Characteristics (25°C)

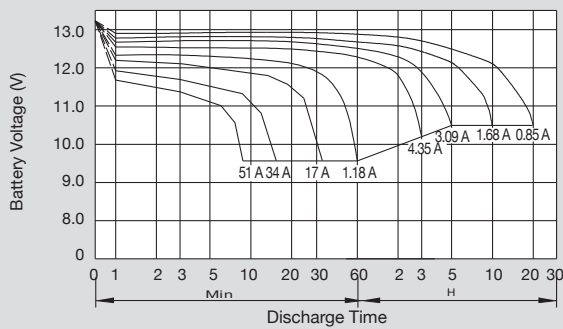

Constant Voltage Charging Characteristic (0.25 CA, 25°C)

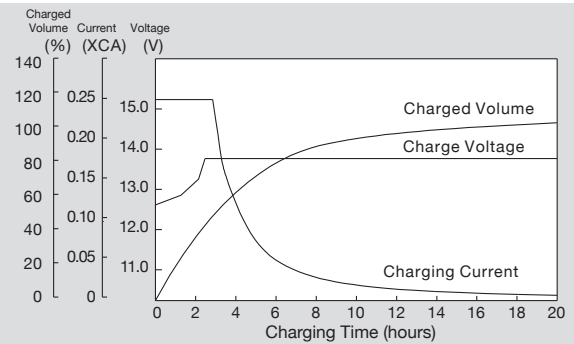

Relationship Between Charging Voltage and Temperature

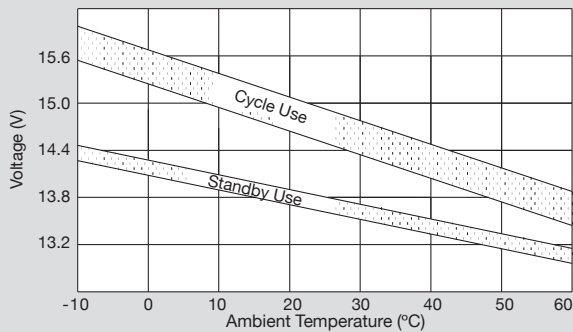

Life Characteristics of Standby Use

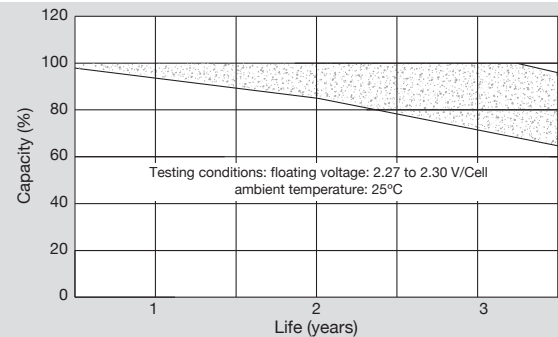

Cycle Service Life in Relation to Depth of Discharge

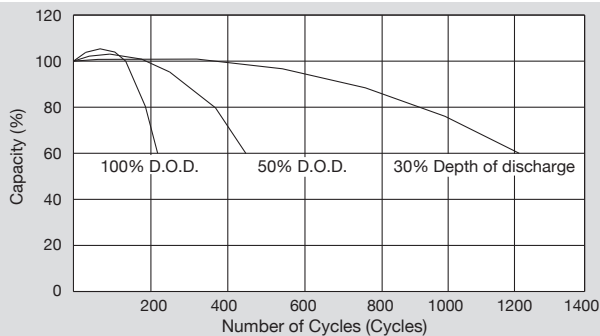

Temperature Effects on Capacity

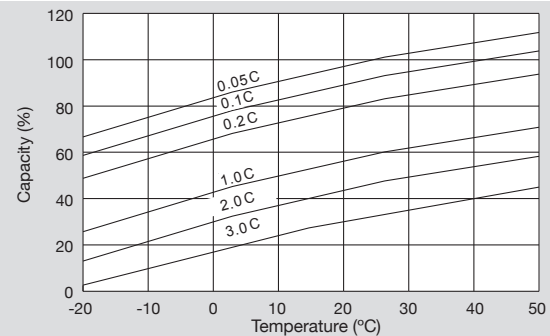

SYSTEMS SUNLIGHT S.A.

Headquarters

2 Ermou & Nikis Str., Syntagma Sq.
105 63 Athens, Attica, Greece

T +30 210 6245400 F +30 210 6245409

European Manufacturing Plant

672 00 Neo Olvio, Xanthi, Greece

T +30 25410 48100 F +30 25410 95446

Global Service Department

366 Tatoiou Str.

136 73 Acharnes, Attica, Greece

T +30 210 6245600 F +30 210 6245619

