

# AccuForce 12V - 100Ah S

## Solar VRLA Battery



### Specifications

Nominal Voltage	12 V	
Number of cells	6	
Cycle Life	Approx. 800 cycles at 50% DOD	
Dimensions	Length	330 mm
	Width	171 mm
	Height	214 mm
	Total Height	220 mm
Approx. Weight	27.5 kg	
Nominal Capacity (25°C)	120 hours rate (0.98 A, 11.1 V)	117.6 Ah
	100 hours rate (1.16 A, 11.1 V)	116.0 Ah
	48 hours rate (2.28 A, 10.8 V)	109.4 Ah
	10 hours rate (9.90 A, 10.8 V)	99.0 Ah
	5 hours rate (17.2 A, 10.5 V)	86.0 Ah
Max. Discharge Current (25°C)	1000 A (5s)	
Internal Resistance	4.8 mOhms	
Fully Charged battery (25°C)	4.8 mOhms	
Self-Discharge	3% of capacity declined per month at 25°C (average)	
Operating Temperature Range	Discharge	-15°C~50°C
	Charge	-10°C~50°C
	Storage	-20°C~50°C
Short Circuit Current	2650 A	
Charging Characteristics (25°C)	Cycle use	2.40-2.48 Vpc
	Maximum charging current	30 A
	Temperature compensation	-30 mV/°C
	Standby use	2.27-2.35 Vpc
	Temperature compensation	-18 mV/°C

### Applications

- Solar / Wind power systems
- Residential installations
- Golf carts and electric powered vehicles
- Marine equipment
- Electric wheelchairs
- Traffic systems (signaling and lighting)
- Remote monitoring and controlling
- Power tools and cleaning machines
- Uninterruptible power supply (UPS)

### Battery Construction

Component	Positive Plate	Negative Plate	Container	Cover	Safety Valve	Terminal	Separator	Electrolyte
Raw material	Lead dioxide	Lead	ABS	ABS	Rubber	Copper	Fiberglass	Sulfuric acid

### Dimensions

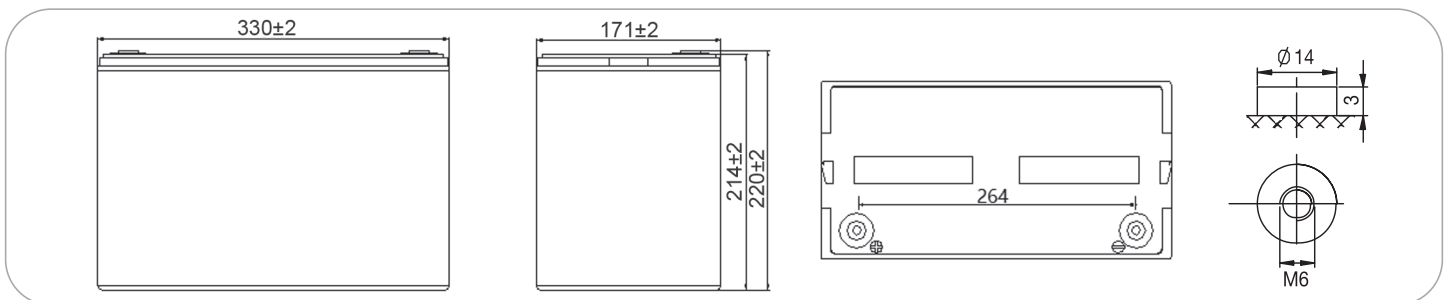

### Constant Current Discharge (Amperes) at 25°C

End Voltage (Volts/Cell)	15min	30min	1h	2h	3h	4h	5h	8h	10h	12h	20h	48h	72h	100h	120h
1.60 V	157	96.0	59.5	35.4	24.7	20.3	17.5	12.0	10.1	8.58	5.29	---	---	---	---
1.65 V	153	94.1	58.7	35.2	24.6	20.2	17.3	12.0	10.1	8.58	5.28	---	---	---	---
1.70 V	147	91.2	57.1	34.9	24.4	20.0	17.2	11.9	10.0	8.50	5.27	2.31	---	---	---
1.75 V	143	89.0	56.0	34.4	24.3	19.9	17.2	11.8	10.0	8.50	5.24	2.30	1.55	---	---
1.80 V	135	85.7	54.2	33.6	23.6	19.3	16.7	11.4	9.90	8.42	5.20	2.28	1.54	---	---
1.85 V	127	80.5	50.9	31.6	22.2	18.1	15.7	10.7	9.31	7.92	4.89	2.14	1.45	1.16	0.98

### Constant Power Discharge (Watts) at 25°C

End Voltage (Volts/Cell)	15min	30min	1h	2h	3h	4h	5h	8h	10h	12h	20h	48h	72h	100h	120h
1.60 V	1721	1077	679	410	291	239	207	142	121	103	63.5	---	---	---	---
1.65 V	1680	1056	668	408	289	237	206	142	120	102	63.4	---	---	---	---
1.70 V	1618	1023	652	404	287	236	204	141	120	102	63.2	27.8	---	---	---
1.75 V	1563	998	638	399	285	234	203	140	119	101	62.8	27.6	18.6	---	---
1.80 V	1480	962	619	388	276	227	197	135	118	100	62.4	27.4	1.85	---	---
1.85 V	1390	905	580	365	260	213	185	127	111	94.2	58.6	25.8	17.3	13.8	11.8

Note: The above characteristics data can be obtained within three charge/discharge cycles.

# AccuForce 12V - 100Ah S Solar VRLA Battery

## Typical Use Life and Operating Temperature

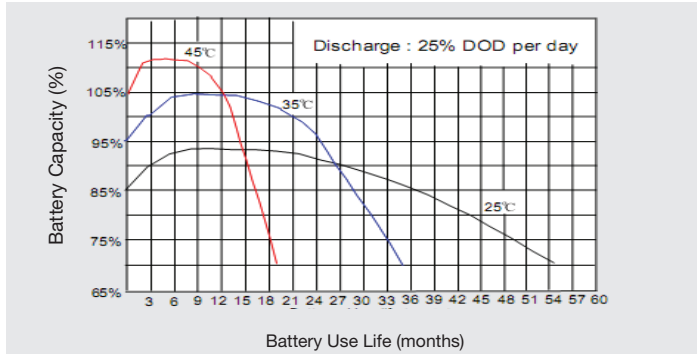

## Self Discharge Characteristics

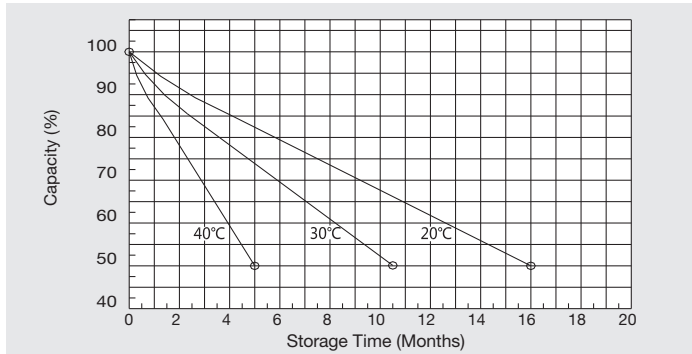

## Discharge Characteristics (25°C)

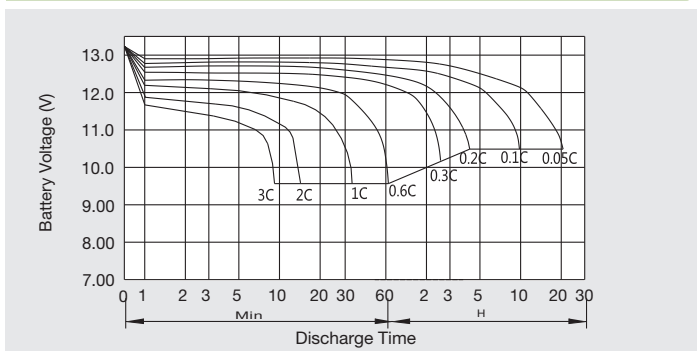

## Charging Characteristics (25°C)

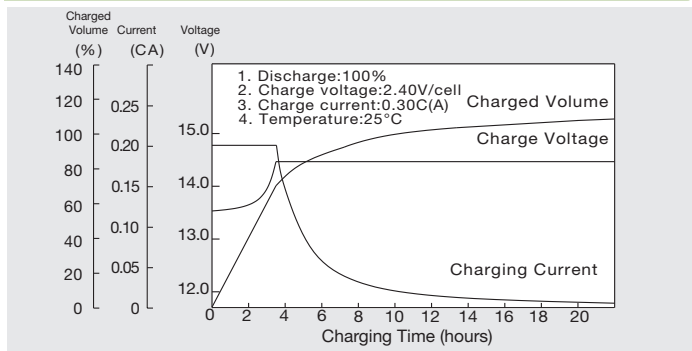

## Relationship Between Charging Voltage and Temperature

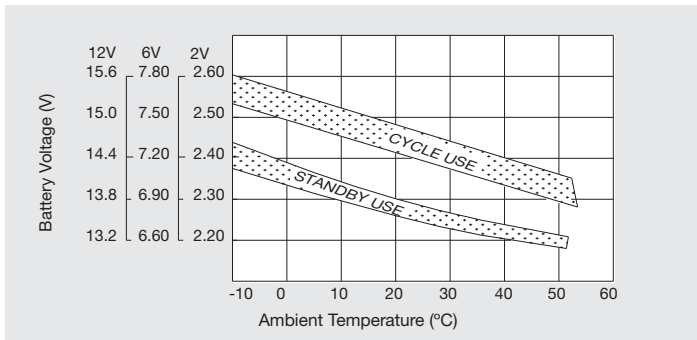

## Relationship Between OCV and Residual Capacity (25°C)

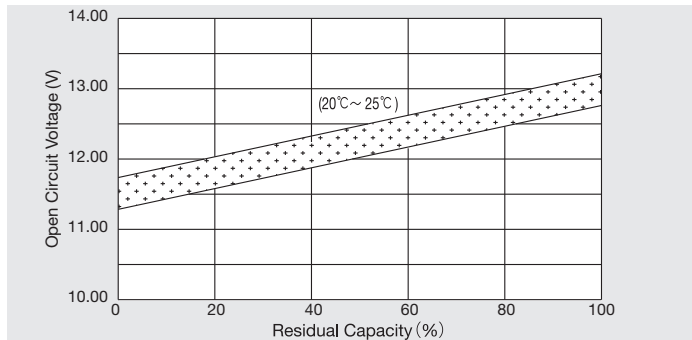

## Cycle Service Life in Relation to Depth of Discharge

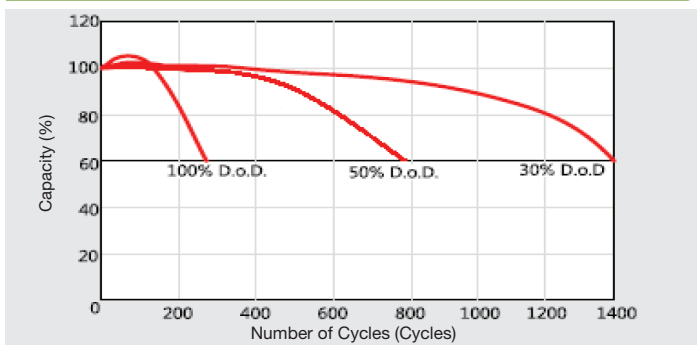

## Temperature Effects on Capacity

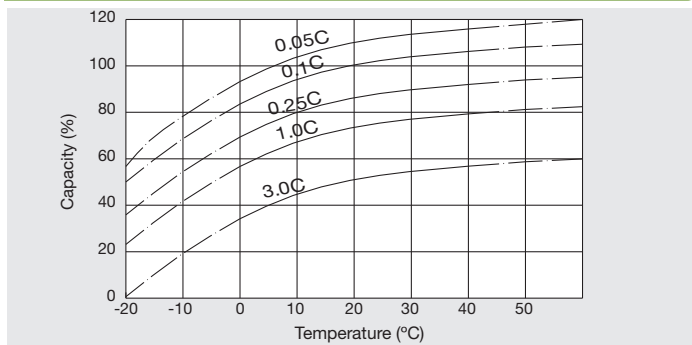

### SYSTEMS SUNLIGHT S.A.

#### Headquarters

2 Ermou & Nikis Str., Syntagma Sq.  
105 63 Athens, Attica, Greece

T +30 210 6245400 F +30 210 6245409

#### European Manufacturing Plant

672 00 Neo Olvio,  
Xanthi, Greece

T +30 25410 48100 F +30 25410 95446

#### Global Service Department

366 Tatoiou Str.  
136 73 Acharnes, Attica, Greece

T +30 210 6245600 F +30 210 6245619