

# AccuForce 12V - 55Ah S

## Solar VRLA Battery



### Specifications

Nominal Voltage	12 V	
Number of cells	6	
Cycle Life	Approx. 800 cycles at 50% DOD	
Dimensions	Length	229 mm
	Width	138 mm
	Height	208 mm
	Total Height	211 mm
Approx. Weight	16.5 kg	
Nominal Capacity (25°C)	120 hours rate (0.51 A, 11.1 V)	61.2 Ah
	100 hours rate (0.61 A, 11.1 V)	61.0 Ah
	48 hours rate (1.25 A, 10.8 V)	60.0 Ah
	10 hours rate (5.45 A, 10.8 V)	54.5 Ah
	5 hours rate (9.44 A, 10.5 V)	47.2 Ah
Max. Discharge Current (25°C)	550 A (5s)	
Internal Resistance	6.5 mOhms	
Fully Charged battery (25°C)	6.5 mOhms	
Self-Discharge	3% of capacity declined per month at 25°C (average)	
Operating Temperature Range	Discharge	-15°C~50°C
	Charge	-10°C~50°C
	Storage	-20°C~50°C
Short Circuit Current	5420 A	
Charging Characteristics (25°C)	Cycle use	2.40-2.48 Vpc
	Maximum charging current	16.5 A
	Temperature compensation	-30 mV/°C
	Standby use	2.27-2.35 Vpc
	Temperature compensation	-18 mV/°C

### Applications

- Solar / Wind power systems
- Residential installations
- Golf carts and electric powered vehicles
- Marine equipment
- Electric wheelchairs
- Traffic systems (signaling and lighting)
- Remote monitoring and controlling
- Power tools and cleaning machines
- Uninterruptible power supply (UPS)

### Battery Construction

Component	Positive Plate	Negative Plate	Container	Cover	Safety Valve	Terminal	Separator	Electrolyte
Raw material	Lead dioxide	Lead	ABS	ABS	Rubber	Copper	Fiberglass	Sulfuric acid

### Dimensions

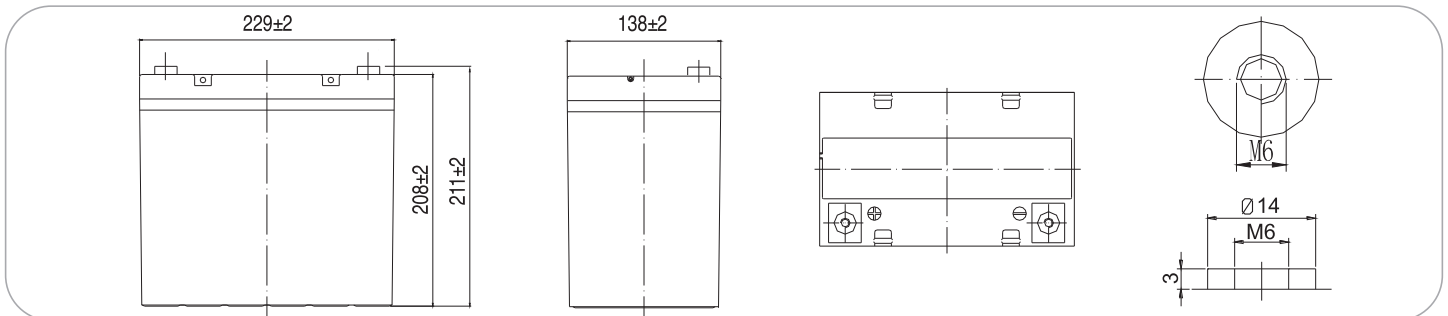

### Constant Current Discharge (Amperes) at 25°C

End Voltage (Volts/Cell)	15min	1h	2h	3h	4h	5h	8h	10h	12h	20h	48h	72h	100h	120h
1.60 V	86.3	32.7	19.5	13.6	11.2	9.62	6.60	5.54	4.71	2.91	1.27	---	---	---
1.65 V	84.2	32.3	19.4	13.5	11.1	9.56	6.56	5.53	4.70	2.90	1.27	---	---	---
1.70 V	81.1	31.4	19.2	13.4	11.1	9.50	6.52	5.51	4.69	2.90	1.27	---	---	---
1.75 V	78.3	30.8	18.9	13.4	11.0	9.44	6.47	5.48	4.66	2.88	1.26	---	---	---
1.80 V	74.1	29.9	18.4	12.9	10.6	9.15	6.27	5.45	4.63	2.86	1.25	0.87	---	---
1.85 V	69.5	28.4	17.6	12.3	10.1	8.72	6.15	5.34	4.53	2.81	1.22	0.85	0.61	0.51

### Constant Power Discharge (Watts) at 25°C

End Voltage (Volts/Cell)	15min	1h	2h	3h	4h	5h	8h	10h	12h	20h	48h	72h	100h	120h
1.60 V	946	373	226	160	131	114	78.4	66.2	56.3	34.9	15.3	---	---	---
1.65 V	924	368	224	159	130	113	77.9	66.0	56.1	34.8	15.3	---	---	---
1.70 V	890	358	222	158	130	113	77.4	65.8	56.0	34.7	15.2	---	---	---
1.75 V	860	351	219	157	129	112	76.8	65.4	55.6	34.6	15.2	---	---	---
1.80 V	814	341	213	152	125	108	74.6	65.0	55.3	34.4	15.1	10.6	---	---
1.85 V	765	323	204	145	118	103	73.2	63.6	54.2	33.6	14.7	10.4	7.58	6.35

Note: The above characteristics data can be obtained within three charge/discharge cycles.

# AccuForce 12V - 55Ah S Solar VRLA Battery



## Typical Use Life and Operating Temperature

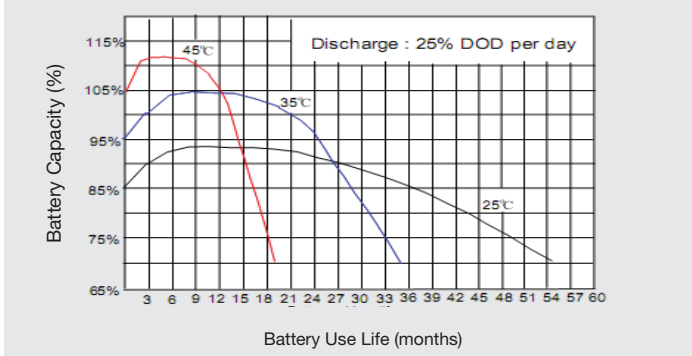

## Self Discharge Characteristics

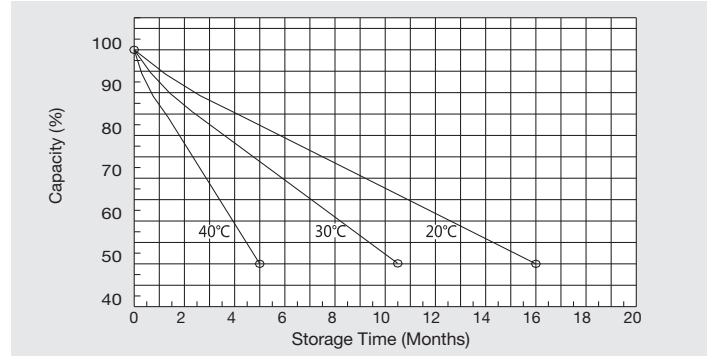

## Discharge Characteristics (25°C)

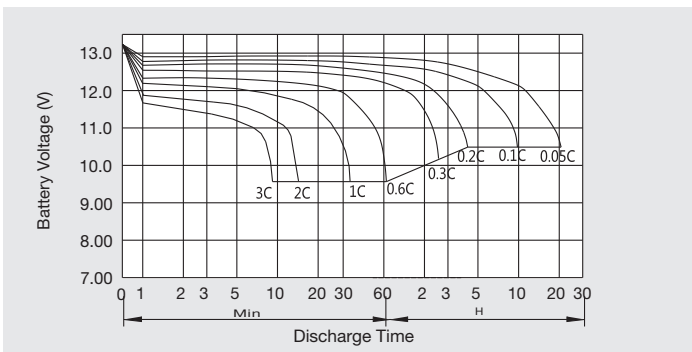

## Charging Characteristics (25°C)

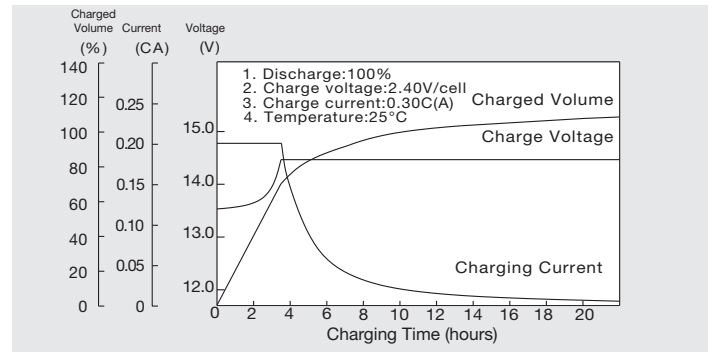

## Relationship Between Charging Voltage and Temperature

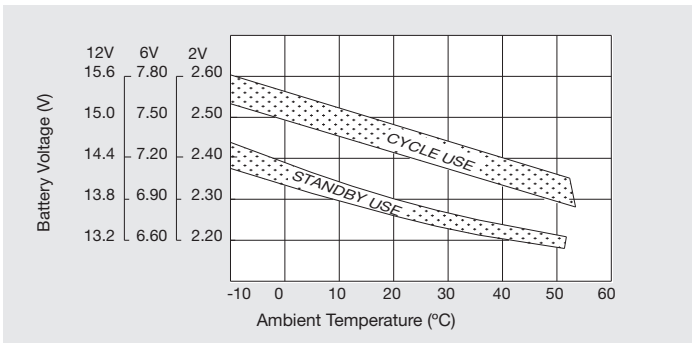

## Relationship Between OCV and Residual Capacity (25°C)

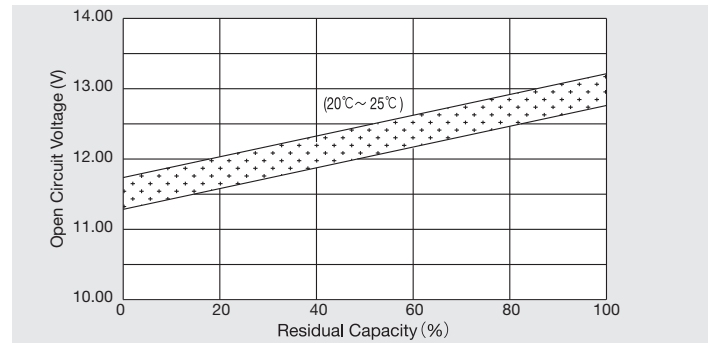

## Cycle Service Life in Relation to Depth of Discharge

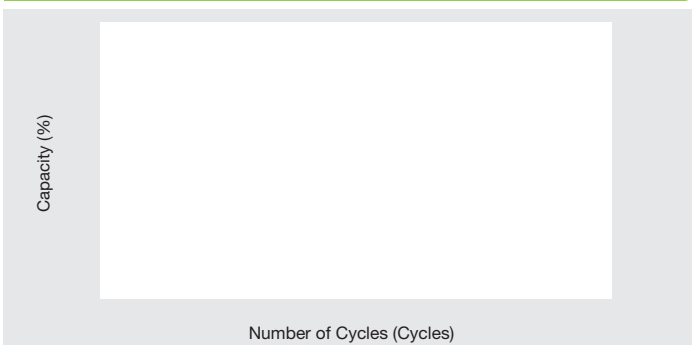

## Temperature Effects on Capacity

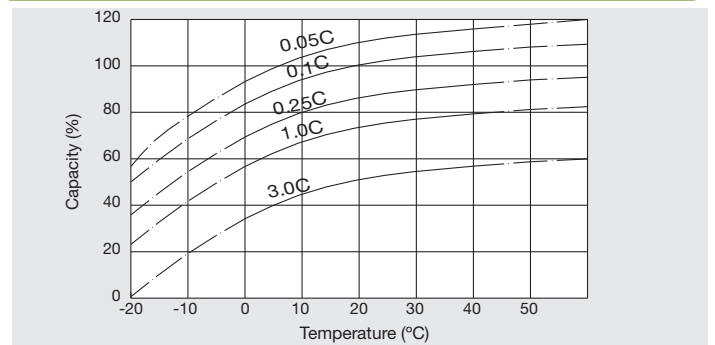

### SYSTEMS SUNLIGHT S.A.

#### Headquarters

2 Ermou & Nikis Str., Syntagma Sq.  
105 63 Athens, Attica, Greece

T +30 210 6245400 F +30 210 6245409

#### European Manufacturing Plant

672 00 Neo Olvio,  
Xanthi, Greece

T +30 25410 48100 F +30 25410 95446

#### Global Service Department

366 Tatoiou Str.  
136 73 Acharnes, Attica, Greece

T +30 210 6245600 F +30 210 6245619